

mindo

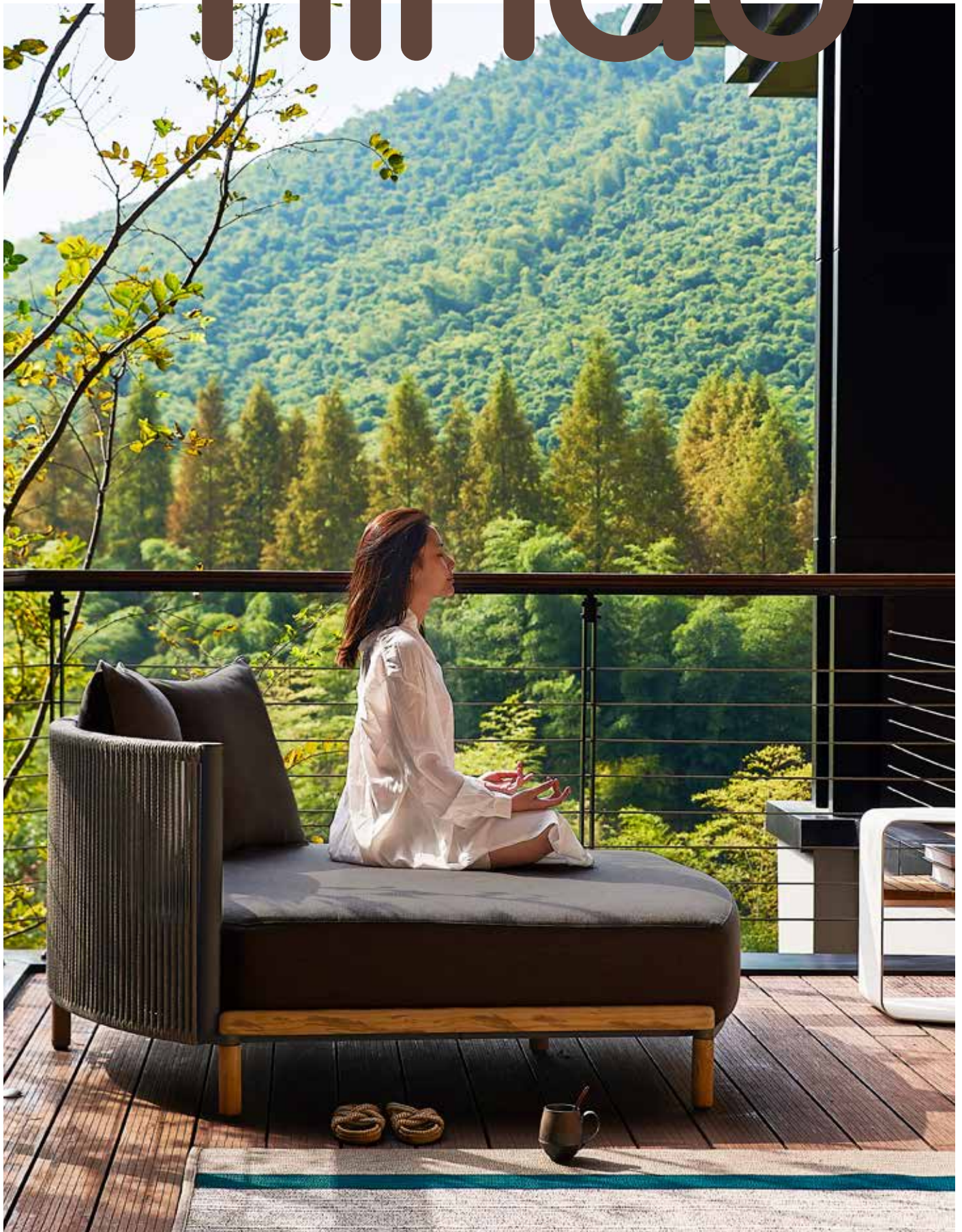

OUTDOOR COLLECTION 2026 • MADE FOR MOMENTS



This is an invitation to slow down, step outside and create places to feel at ease, grounded, and welcome.

At mindo, we design outdoor furniture for real life. Not for display, not for performance - but for the hours when time softens and people stay a little longer than planned. We believe the outdoors is not an escape from everyday life. It is where everyday life becomes whole again.

Life has become faster and more digital. Many of us spend our days indoors, in front of screens. Outdoors offers something different: time that moves more slowly, materials you can feel, and space to be together.

This is where mindo fits in.

Our furniture is designed to support this return. Calm forms. Tactile surfaces. Proportions that invite the body to relax and the conversation to unfold. We work with materials that age with dignity and designs that do not ask for attention, but reward time. Pieces made to hold long evenings, shared meals, silence, laughter, and the simple joy of being together.

Mindo is built on the belief that nature, connection, and care are inseparable. When we sit well, we listen better. When we feel supported, we open up. Outdoor furniture becomes more than objects - it becomes infrastructure for presence.

This catalogue is an invitation. To slow down. To step outside. To create places where people feel at ease, grounded, and welcome. Places where nothing needs to be optimized. Where being is enough.

Happy reading!
Thomas Overby Andersen, CEO

6



OUR DESIGNERS

The creative minds behind mindo – shaping spaces through thoughtful design.

LOUNGE

Sink in, slow down, and settle into comfortable lounge furniture.



8

DINING

Where a cup of coffee or a meal turn into moments to remember.



76

140



RESPONSIBILITY

Created with care – for people, for places, and for years to come.

LIVING

All the pieces that bring ease and atmosphere to your outdoor space.



146

MATERIALS

Honest, enduring materials chosen for their beauty, strength, and feel.

182



Our designers

At mindo, we are proud of the relationship we have with our designers. We share a love for aesthetics, functional design, and high craftsmanship. And we share a passion for details and a mindset, where we aim to push “good enough” to something better.



Rikke, a Danish designer, has run her design studio in Århus since 2004. When designing, Rikke focuses on the relevance and longevity of a product and its impact on our environment, both now and in the future. Rikke’s designs for mindo are minimal without ever losing comfort, functionality, or aesthetic magic. Her furniture has a playful quality to it, which she emphasizes with thoughtful details for the user to discover and engage with.



Christian is a gifted Danish design talent who has won numerous prestigious prizes, amongst them the renowned Finn Juhl design prize (there is no family connection). He feels that part of his strength as a furniture designer stems from his background in carpentry. For mindo, Christian used innovative 3D-knit, a fabric made from recycled bottles to create the unique mindo 114 chairs. Central to Christian’s design philosophy is the aim that his furniture serves a purpose and is functional, regardless of its sculptural aesthetic.



The Valencia-based design-agency Odosdesign, namely Ana Segovia and Luis Calabuig, are dedicated to integrating creativity and communication in product design. In their collaboration with mindo, their success lies in the ability to understand and translate our vision into furniture that truly embodies our initial ideas. By emphasizing the core element of each creation and placing focus on comfort and usability, their iconic designs accurately convey our mindo mindset.



Thomas is a Danish designer with a design studio in the heart of Copenhagen. Central to Thomas’ design philosophy is the interaction between a product and its user, his creative process always starts with an understanding of the user’s needs. Thomas shares mindo’s meticulous attention to detail and materials that are the responsible choice in terms of sustainability and longevity. Privately, Thomas draws inspiration from the dynamic interplay between the established and modern design scene of the bustling city, as well as his passion for simple living in the countryside.



Jesper is a Danish versatile talent, both a creative industrial designer and a detail-oriented inventor. His dedication to any product he works with stems from his holistic approach to innovation and problem-solving. His own aversion to handling and storing large extension plates when hosting many guests led him to the ingenious design of a table with an extendable top. This unique solution resulted in a patent in cooperation with mindo and the backbone of a large range of extension tables and benches, namely the mindo 111 series.

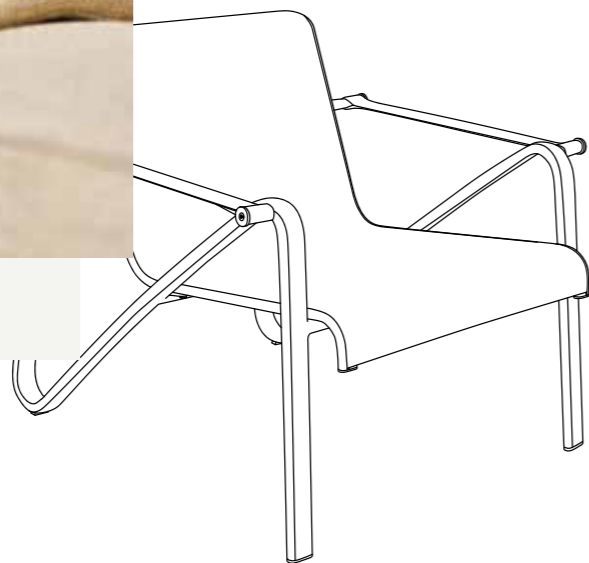

mindo LOUNGE

The Lounge collection is made for slowing down. For long afternoons, soft conversations, and evenings that unfold without hurry. For sinking in, leaning back, and staying a while. Furniture that lets time pass without noticing.



Sofas, lounge chairs, and low tables.
Comfortable, durable, and easy to live with.



mind
122

Lounge furniture that adapts naturally over time - and stays with you, for the long run.



Designed by:
Thomas E. Alken



mind
122

mindo 122 2-Seater Sofa L149 cm · W91 cm · H68 cm · SH37 cm |
mindo 122 Coffee Table Small L79 cm · W61 cm · H27 cm

mindo 122



mindo 122 3-Seater Sofa L209 cm · W91 cm · H68 cm · SH37 cm |
 mindo 122 Coffee Table Large L115 cm · W79 cm · H36 cm

Made for being outside with the comfort you would expect indoors.



mindo 122 Side Table L54 cm · W31 cm · H58 cm



mindocom 122

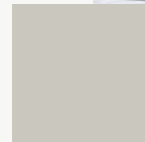

Light Grey

Designed to come apart.
Designed to last.
Season after season.

mindocom 122 is designed with longevity in mind - both structurally and practically. Every element is considered for life outdoors, across changing seasons and shifting weather. The cushions are weather-resistant and easy to maintain. A passing summer rain is not a problem. Daily use is not a concern. What sets the collection apart is what happens when the season changes.



The side and back panels are fully removable. To prepare for storage, simply loosen two small screws on the armrests. Unzip the panels beneath the frame and lift them off. The process takes minutes and protects the upholstered elements during the off-season. When spring returns, the sofa is just as easy to reassemble - restored to its original form, comfort, and stability.



mind **107**

Soft in form.
Generous in comfort.
Made for time
spent outside.



Designed by:
Rikke Frost



mindo 107

Made for being together without doing much. Just sitting, talking, and staying a little longer.

mindo 107 3-Seater Sofa L232 cm · D88 cm · H66 cm · SH42 cm | **mindo 107 Lounge Chair** L95 cm · D77 cm · H66 cm · SH42 cm

mindo 107



mindo 107 Lounge Chair L95 cm · D77 cm · H66 cm · SH42 cm | mindo 107 Footstool Ø71 cm · H40 cm | mindo 107 Side Table Ø57 cm · H46 cm

Come and sit.
Not to do something.
Just arrive and be here.





Dark Grey

Warm elements - teak, rope, and fabric - are balanced with cool aluminium and a ceramic tabletop.

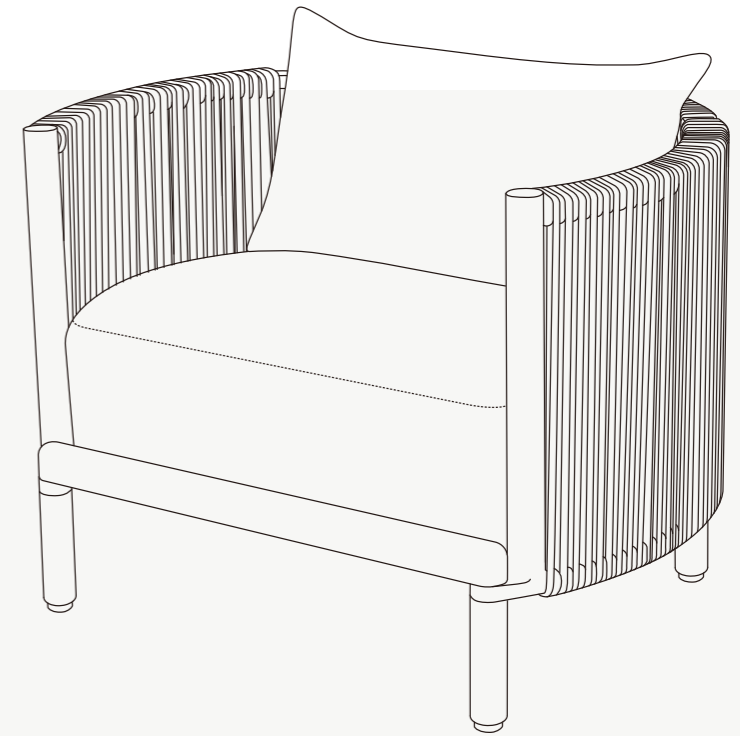

Designed through material, experienced through comfort.

Rope adds softness and strength. Teak brings warmth and a natural feel. Aluminium provides stability while keeping the construction light.

The ceramic tabletop may look delicate, but it is hard-wearing and well-suited for outdoor use. Each material has a clear purpose, chosen for performance.



mindocom 107

Loose cushions allow you to sit, lean back, or stretch out in your own way. The open, relaxed forms support conversation, reading, resting, and quiet moments in between.



mindō 100

Made for time together. When outdoor space becomes part of daily life, with room for everyone.



Designed by:
Thomas E. Alken



mindo 100 3-Seater Sofa L216 cm · D90 cm · H64 cm · SH40 cm | mindo 100 Coffee Table L83 cm · W83 cm · H40 cm

mindo **100**



mindo **100**

mindo 100 2-Seater Module Left/Right L160 cm · D90 cm · H64 cm · SH40 cm | mindo 100 Side Table Ø58 cm · H47 cm

mindo 100



mindo 100 Lounge Chair L86 cm · D90 cm · H64 cm · SH40 cm

A lounge that adapts to its surroundings so time together can take its own shape.



mindo 100 Lounge Group L250 cm · W250 cm · H64 cm · SH40 cm | mindo 100 Coffee Table L83 cm · W83 cm · H40 cm





Designed for everyday outdoor use, long conversations, and quiet moments – without demanding attention or care.

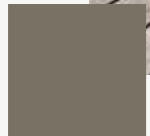
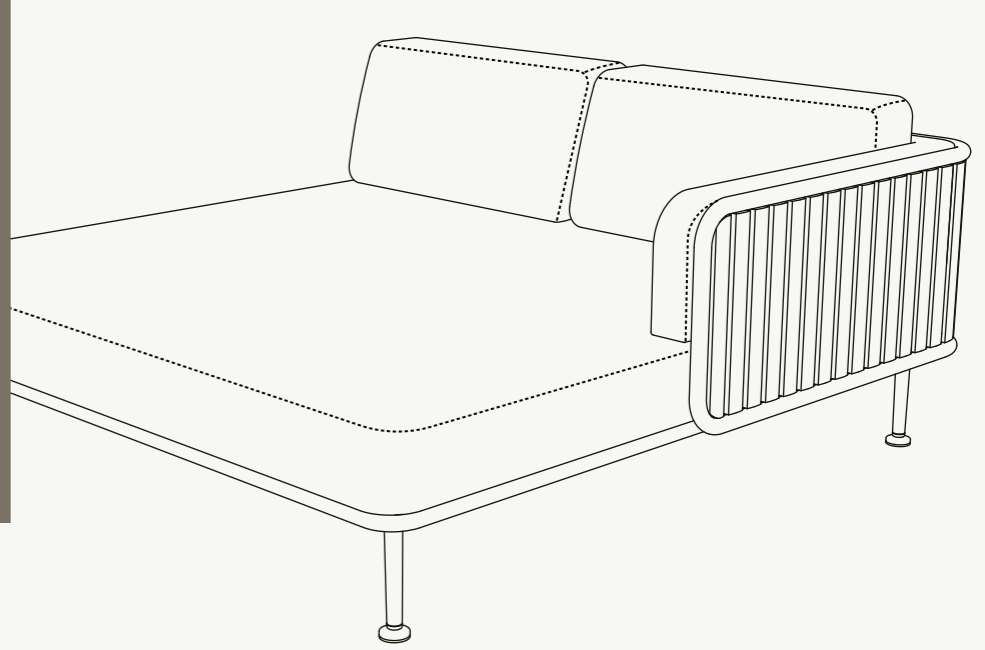

Warm Grey

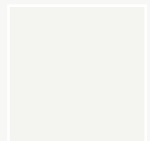

Off White

Made to be used.
And to age naturally.



mindocom 100



Cushions are made with memory foam and covered in weather-resistant Sunbrella fabric for a relaxed seating experience.

Teak is made for outdoor use and will gradually shift from a warm tone to a natural grey. The individually replaceable slats allow the wood to age naturally, making long-term care simple and helping the lounge group stay in use for years.



mindo 100



With seven different modules, the possibilities for creating your personal lounge environment are practically endless.

Depending on your available space, you can join corner modules with 2-seaters or daybed modules, then add single or double seaters to extend infinitely.

Go beyond the modular setting and add stand-alone elements for a unique look. Our mindo 100 lounge chair, the generous daybed, or our comfortable 3-seater sofa are fantastic additions yet shine just as brightly on their own.

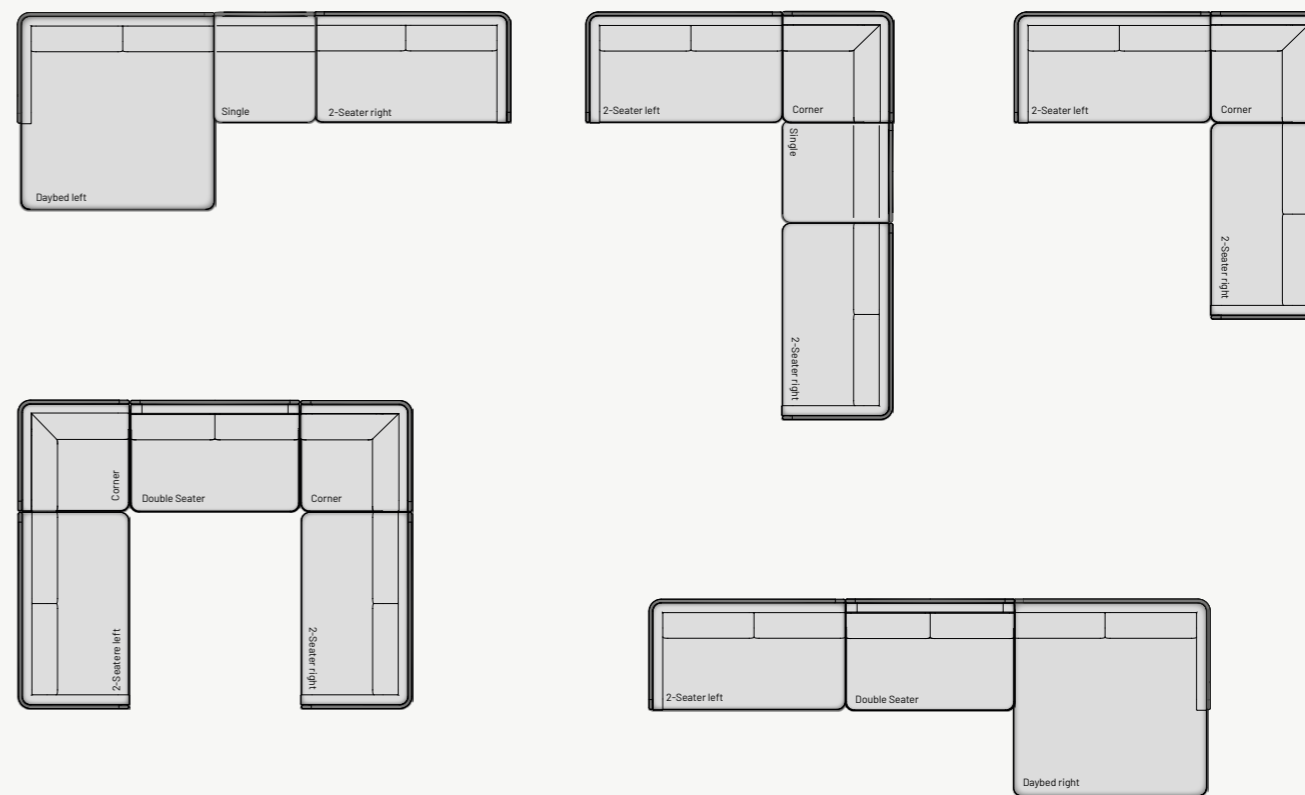

mindō 105

Relaxed by design.
Easy to live
with in everyday
outdoor moments.



Designed by:
Thomas E. Alken



mind
105

Made for easy days
outside, with less to
think about.

mind 105 2-Seater Sofa L137 cm · W87 cm ·
H72 cm · SH39 cm

mindo 105



By the pool, on the terrace, or in the garden?

A light, movable chair and footstool – easy to place where it feels right. Rounded aluminium profiles and soft Batyline Eden fabric create a relaxed seating experience without sharp edges or visual noise.



mindo 105 Lounge Chair L77 cm · D88 cm · H72 cm · SH39 cm | mindo 105 Footstool L58 cm · D52 cm · H38 cm





mindó 105

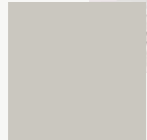

Light Grey



Dark Grey

Let it rain. Pat it dry.
Use it again.

The quick-drying Batyline Eden fabric gives the mindo 105 collection a soft, almost wool-like feel, while remaining fully suited for outdoor life. The airy weave allows water to pass through and dry quickly after rain or swimming. Any remaining droplets can simply be wiped off. No fuss. No waiting.



mindo 105



A subtle yet vital detail is the gently curved, diagonal aluminium profile that strengthens the frame of the chair, footstool, and sofa. An understated construction choice that adds stability without changing the look. Just sit down.



mind **106**

Structure you can
see. Texture and
comfort you can feel.



Designed by:
Odosdesign



mindo 106 2,5-Seater Sofa L180 cm · D90 cm · H78 cm · SH43 cm | **mindo 106 Lounge Chair** L90 cm · D90 cm · H78 cm · SH43 cm | **mindo 106 Footstool** L74 cm · D59 cm · H43 cm | **mindo 106 Coffee Table** L120 cm · W60 cm · H30 cm

mindo **106**



mindo 106

The high back offers a sense of shelter and creates a place to sit, talk or stay quiet, enjoying the surroundings.

mindo 106 High Back Lounge Chair
L90 cm · D90 cm · H120 cm · SH43 cm



mindo 106 High Back Lounge Chair L90 cm D90 cm H120 cm SH43 cm

Light Grey



Dark Grey

Its all about comfort, style, and that ultimate relaxed vibe.

A weather-resistant ceramic top with two integrated levels makes the coffee table a distinctive complement to the lounge group.



Quick-dry foam cushions offer a firmer, supportive sit and let water pass through - made for outdoor life.

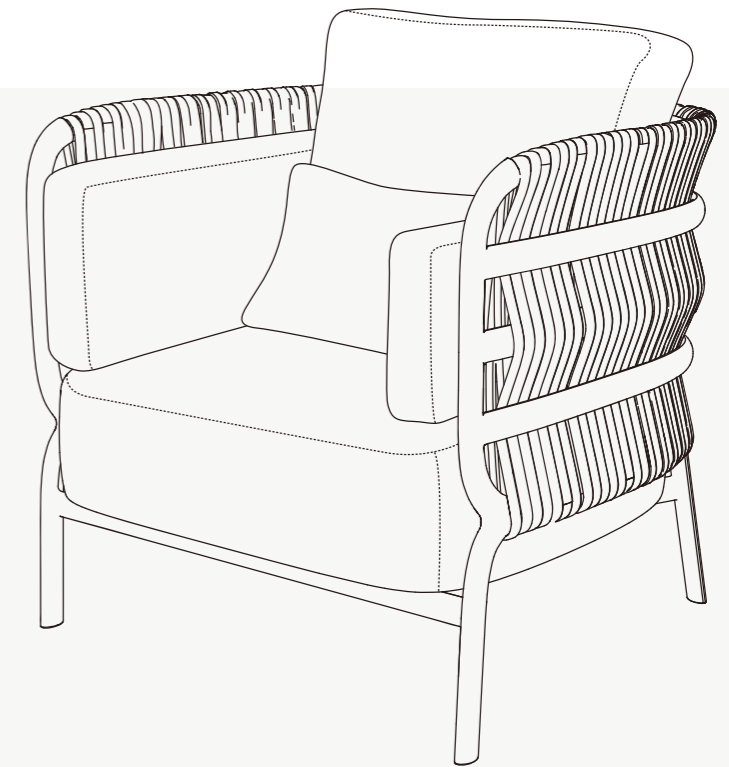

mindo 106



Mindo 106 is built around a visible aluminium frame and with a wide, flat rope weave. The rope is woven in and out of the structure, providing support and well suited for open settings by the sea, in gardens, or on large decks.



mindo 124



Designed by:
Jesper K. Thomsen

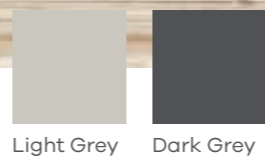

Just an easy lounge chair. Light, comfortable, and simple to live with.

Lightweight and stackable, both the lounge chair and the side table are easy to move, store, and adapt to changing needs.

An optional cushion can be discreetly fastened underneath when not in use.

The seat and back can be replaced if needed, extending the life of the chair and making maintenance simple over time.



mindo 124 Lounge Chair L68 cm · W66 cm · H74 cm · SH38 cm

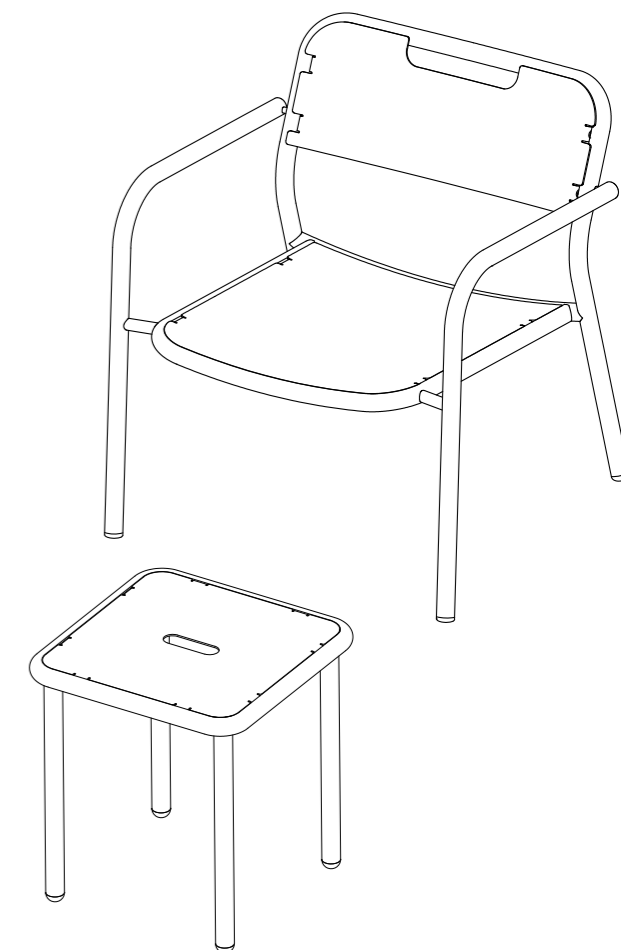

mind **101**

Lean back.
Relax. Stay longer.



Designed by:
Thomas E. Alken



mindo 101

The open backrest allows different sitting positions, giving the body room to shift, lean, and relax without constraint.

mindo 101 Lounge Chair L72 cm · D72 cm ·
H75 cm · SH36 cm

mindo 101



Light Grey Dark Grey



mind **114**

Soft to the touch.
Bold in form.
And comfort that
invites you to linger.



Designed by:
Christian Juhl

mind
114



Mindo 114 Lounge Chair L76 cm · D71 cm · H86 cm · SH43 cm

The mindo 114 lounge chair is an open invitation to sit down, settle in, and stay awhile.



Its soft 3D-knit fabric - made from recycled plastic bottles - meets the body with a gentle, breathable comfort that feels easy from the first moment. A clean aluminium frame keeps the design light, while the distinct backrest provides steady support, no matter how you sit.



mind **118**

Welcome to your
private outdoor retreat,
where light, shadow,
and comfort meet.

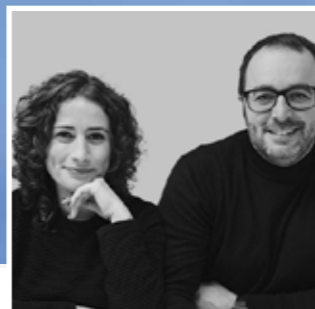

Designed by:
Odosdesign



mind
118

mindo 118 High Back Lounge Chair L79 cm · D94 cm · H112 cm · SH42 cm | mindo 118 Side Table Ø50 cm · H45 cm

mindocom 118



A sheltered seat,
open to the view and
the day unfolding.

Weather-resistant cushions offer relaxed comfort. An aluminium frame brings clarity, balanced by solid teak legs for warmth and stability. The side table continues this mix of lightness and solidity.



mindo 113

Ease, reliability, and the freedom to sit back and enjoy.



Designed by:
mindo

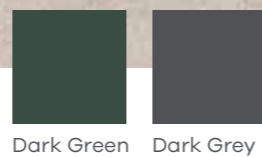

Dark Green Dark Grey



This lounge chair is designed to feel right - without asking for attention. Its straightforward expression makes it easy to place and easy to live with, whether in a hotel courtyard, a spa terrace, a ski lodge, or a summer house by the sea.



Mindo 113 Lounge Chair L79 cm · D87 cm · H92 cm



The open mesh seat allows rainwater to drain quickly, so the chair can stay outdoors year-round with minimal care. The result is a durable, practical lounge chair that prioritizes comfort over complication. Add the weather-resistant cushions when you want extra softness, or keep it pared back.



mindo DINING

The Dining collection brings people together. For long meals, short breaks, and everything in between. Comfortable seating and generous tables made for everyday use. Because the best moments often last longer than planned. Designed to be shared, used, and returned to – season after season.

reddot winner 2024 



Tables, chairs,
and benches for
eating, sharing,
and staying.
Made for life
outdoors.



mindó 111

A flexible dining system
that grows with
people, occasions, and
everyday moments.



Designed by:
Jesper K. Thomsen



mindob **111**

Meet a collection of extension tables and benches built around a single, radical idea: making more space should feel effortless.

mindob 111 Balcony Table L162/201 cm · W60 cm · H74 cm | **mindob 111 Bench Small** L139/173 cm · W42 cm · H46 cm

More guests?
Space comes easy with the extension table.
Just pull and make room.

mind
111

mindo 111 Dining Table Large L263/327 cm · W100 cm · H74 cm

mindo 111



mindo 122 2-seater sofa L149 cm · W91 cm · H68 cm · SH37 cm | mindo 111 Dining Table Small L162/201 cm · W90 cm · H74 cm

Clean lines and calm colours allow the tables to pair naturally with a wide range of chair designs, adapting quietly to different settings and styles.



mindo 111



mindo 111 Bench Large L240/300 cm · W45 cm · H46 cm





Small in width. Big in possibility.
At just 60 cm wide, it fits where
space is limited. Benches follow suit –
and slide neatly underneath.

mind
111

mindo 111 Balcony Table L162/201 cm · W60 cm · H74 cm | mindo 111 Bench Small L139/173 cm · W42 cm · H46 cm



Light Grey



Dark Green



Dark Grey

Adaptability is at the heart of the design.

Available in different lengths and widths, mindo 111 tables and benches adapt to balconies, terraces, small and large gatherings alike. Designed to change as life does, they offer a calm, confident solution for coming together - again and again.



mindo 111





mindó 112

A simple chair
that just works.
For everyday use,
year after year.

Designed by:
mindó

mindo 112



mindo 112 Dining Chair L50 cm · D57 cm · H82 cm · SH47 cm

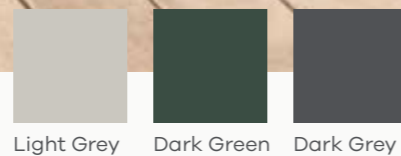

Light Grey Dark Green Dark Grey

The powder-coated aluminium frame is durable, weather-resistant, and easy to maintain, making it well suited for terraces, cafés, and private outdoor spaces alike.

Fully stackable and lightweight, it's easy to move, store, and live with, the chair blends naturally into different settings and pairs effortlessly with a wide range of tables. An honest, practical choice, mindo 112 is created to be used often, and to keep working for years to come.



mind
101

A dining collection made
for time together.
Meal after meal.
Season after season.



Designed by:
Thomas E. Alken



mindo 101 Dining Chair W58 cm · D57 cm · H77 cm · SH48 cm | mindo 101 Dining Table L222 cm · W90 cm · H74 cm

mindo **101**



mindo 101

Round tables invite easy conversation. Warm teak – with a discreet ceramic insert – creates a place for everyday meals and festive get-togethers.

mindo 101 Dining Table Ø120 cm · H75 cm

mindo **101**



Rectangular, square, round, or café-sized. One dining collection, many ways to gather. Designed to fit your space.



mindo 101 Dining Table Square L74 cm · W74 cm · H75 cm | mindo 101 Café Table L74 cm · W74 cm





Light Grey



Dark Grey

Thoughtful materials
in a clever design,
made to last.



Certified teak adds warmth and tactility, complemented by the rope-woven chair backrests. The backrest design supports natural movement for lasting comfort, while the teak ages beautifully and allows for individual slat replacement - ensuring long-term durability and enjoyment.



mindo 101

Durable, weather-resistant ceramic ensures everyday outdoor usability, while the ceramic insert on the teak tables protects the surface from hot and cold items.



mindó 124

Thoughtfully designed.
Easy to maintain. Made to
be used every day.



Designed by:
Jesper K. Thomsen



mindo 124

Made for everyday outdoor living. Light in expression, calm in form, and at home in both private gardens and urban hospitality settings - where function, durability, and visual ease matter.

mindo 124 Dining Table W78 cm · D78 cm · H75 cm | **mindo 124 Dining Chair** W53 cm · D56 cm · H83 cm · SH44 cm | **mindo 124 Dining Armchair** W60 cm · D56 cm · H83 cm · SH44 cm

A practical, well-considered choice – designed to be used often, enjoyed easily, and lived with for years to come.

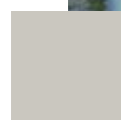

Light Grey



Dark Grey

Made from powder-coated aluminium, the collection is durable, weather-resistant, and easy to live with. Soft, rounded edges create a welcoming expression, while stackable chairs offer flexibility and optional cushions add comfort for longer, relaxed meals.



mindo 124



mind **119**

A familiar garden chair, updated for present and future outdoor moments together.



Designed by:
Thomas E. Alken



mindo 119

Inspired by classic garden furniture, this chair blends familiar lines with modern clarity, refined through thoughtful details.

mindo 119 Dining Chair W60 cm ·
D56 cm · H79 cm · SH45 cm

mindo 119

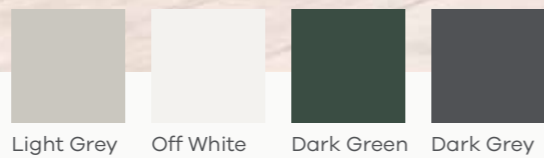

If time leaves its trace, each teak slat can be replaced, extending the life of the chair. The untreated teak seat and back are gently curved, offering quiet comfort for long, unhurried meals.





mindó 119

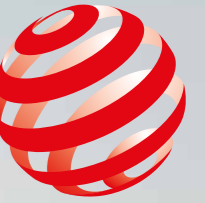

mindo 121

Award-winning design for flexible living, with comfort intact.



Designed by:
Jesper K. Thomsen



mindocom **121**

When space is limited, design becomes essential.

mindocom 121 Foldable Bistro Table L75 cm · W75 cm · H75 cm | **mindocom 121 Foldable Dining Chair** L48 cm · D60 cm · H83 cm · SH45 cm

mindo **121**



Comfort that folds away
when the day is done.

Folding furniture is about living lightly. Mindo 121 folds away with ease yet feels comfortable and welcoming when in use. Easy to move and store, it suits seasonal rhythms and spaces that reset daily.



mindo 121 Foldable Dining Chair Aluminium
L48 cm · D60 cm · H83 cm · SH45 cm

An all-aluminium version offers a durable, low-maintenance option for contract settings. Small and flexible - yet thoughtful, balanced, and made to be used.





mindò 121



reddot winner 2024



Light Grey



Dark Green



Dark Grey

“Long service life and high seating comfort – equally considered.”

– Red Dot Award Jury

Bamboo forms the seat, backrest, and tabletop – a strong, fast growing material chosen for its natural resilience and character. Slightly curved bamboo slats support the body comfortably, and each slat can be replaced individually to extend the life of the furniture.



mind
114

Sublime comfort,
shaped by bold
innovation.



Designed by:
Christian Juhl



No sharp corners.
Just an easy flow
around the oval table
for shared moments.

mindo **114**

mindo 114 Dining Table Oval L215 cm · W95 cm · H75 cm | mindo 114 Dining Chair W55 cm · D58 cm H86 cm SH50 cm

mindocom 114

The 3D-knitted fabric is shaped for the chair, creating a backrest that adapts naturally to the body. Comfort feels immediate and stays steady through long meals.

The sculptural dining chair brings innovation into a soft, inviting form.



mindocom 114 Dining Table Round Ø95 cm · H75 cm

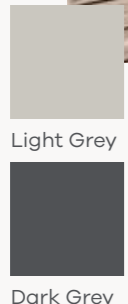

Light Grey

Dark Grey

Tables and chairs, designed to belong together.

Together with the chairs, the materials and proportions align naturally, creating a calm dining setting made for long meals and easy company.



mindocom 114

The balance is immediate. Whether in warm teak or smooth ceramic, each tabletop rests on a die-cast aluminium frame with a softly rounded silhouette - light in expression, grounded in feel.



RESPONSIBILITY

mindocom



At mindo, we create furniture that enhances your space and aligns with a more eco-conscious approach.

Great design shouldn't just look good; it should last. That's why we focus on timeless, functional pieces made with high-quality materials and smart, repairable features. Instead of replacing, you can refresh, extending the life of your furniture and cutting down on waste.

We're rethinking how we work, from sourcing more local materials to shortening supply chains and optimizing packaging. It's all about reducing our footprint while delivering the same durability, premium quality, and faster lead times.

For us, sustainability is a journey. Every decision we make - choosing replaceable teak slats or designing rope panels you can switch - brings us closer to better balance. And for you? It's about owning furniture that feels right and lasts through the years, from the day you bring it home to the day you pass it on. With mindo, you're choosing furniture that fits your space, your values, and a smarter future.



mindó

102

High dining,
designed for
comfort and easy
conversation.



Designed by:
Thomas E. Alken

High dining invites a more relaxed way of being together.

The bar chair builds on the clean lines of the mindo 101 dining chair, reinterpreted for a higher seat. Comfortable and easy to live with, it fits naturally in both hospitality settings and private homes. Pair it with the collection's bar tables in certified teak or durable high-pressure laminate, or place it at the kitchen counter.



mindo 102 Bar Chair W52 cm · D52 cm · H108 cm · SH78 cm |
mindo 102 Bar Table Square W81 cm · D81 cm · H105 cm



mindo 102 Bar Table Rectangular
 L163 cm · W81 cm · H105 cm

A versatile seat for informal dining and everyday gatherings.



mindoliving

Outdoor Living is about the moments in between. A place to pause, stretch out, or set things down. Simple pieces that make being outside feel natural. Not an occasion - just everyday outdoor life.



Benches, sunbeds, side tables, and essentials for outdoor living. Made with the same care and honesty.



mindo 117



Designed by:
Rikke Frost

More than a bench. A place for moments.

With clean lines and balanced materials, the mindo 117 benches fit naturally into many settings without asking for attention. Built from powder-coated aluminium and warm teak, the bench is durable and easy to live with. Available in two sizes, the larger version includes an integrated bowl for herbs, flowers, or cooling a bottle, while the smaller bench keeps the expression clean and minimal.



mindo 117 Bench Small L140 cm · W47 cm · H46 cm





mindó 117

A bench is made for moments in between.
A place to sit down, take in the view,
or share a quiet pause – together or alone.



mindo 117 Bench Large L180 cm · W47 cm · H46 cm

mindo 117



mindob **106**

Sit with a book. Recline into the sun. Comfort without interruption with an easily adjustable backrest.

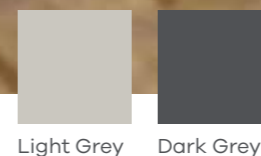

Light Grey Dark Grey

mindob 106 Sunbed L201 cm · W81 cm · SH36 cm

mindo 104



Carry it. Place it. Let it hold your drink.

Lightweight and easy to carry, the table can be placed wherever it's needed. The removable top doubles as a serving tray, making it simple to move between indoors and out. Whether chosen tone-on-tone or as an eye-catching contrast, this little side table adds a sense of ease and functionality to everyday outdoor living.



mindo 104 Side Table Ø40 cm · H60 cm



Designed by:
Thomas E. Alken

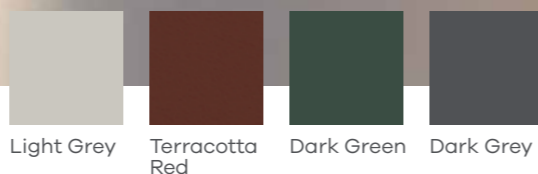



mindó 104

The design brings together simplicity and quiet character. Its organic silhouette echoes the soft forms of a petal or leaf, creating a calm visual rhythm that pairs naturally with the mindo 108 poufs. Teak slats add warmth and tactile texture, balanced by a clean, powder-coated aluminium frame that's made for year-round outdoor use.



mindo 109 Side Table W48x cm · D35 cm · H50 cm

Light, versatile, and easy to place, mindo 109 fits effortlessly into different settings, adding function without interrupting the flow of the space.



mindo 109



Designed by:
Rikke Frost

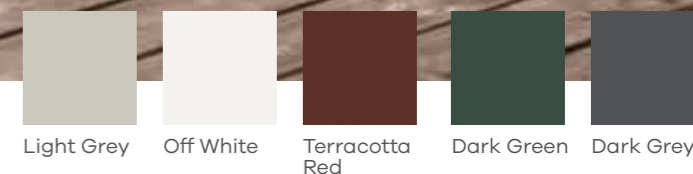

Not square. Not sharp. Just right.
A side table to break the grid.

mindó 109



mindocom 105

Rest, your way. The backrest adjusts easily from fully flat to an upright reading position.

Made from quick-drying Batyline Eden fabric, the sunbed feels soft yet ready for outdoor life. The airy fabric lets water pass through and dries quickly after rain or a swim. Ready whenever you are.

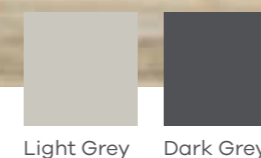

mindocom 105 Sunbed L203 cm · W88 cm · H37 cm

mindø 108

Comfortable companions for adaptable outdoor living.



Designed by:
Rikke Frost



mindó 108

mindo **108**



mindo 108 Pouf Large L74 cm · W65 cm · H35 cm | **mindo 108 Pouf Small** W40 cm · D42 cm · H48 cm

These fun poufs are designed to move easily and adapt naturally. Light enough to carry, yet strong enough to sit on.

Carefully selected colours and textures allow the poufs to blend in or stand out, adding a relaxed touch to any outdoor setting.



An aluminium core provides strength without weight, while quick-dry foam beneath durable outdoor fabric ensures comfort, even after a summer shower.



mindo 120



Designed for effortless indoor and outdoor living, the trolley combines clean lines with practical details that make everyday use feel easy and considered.

A classic helper thoughtfully designed from handle to wheel.



mindo 120 Trolley L98 cm · W61 cm · H80 cm

Crafted from custom aluminium sheets, subtle perforations allow rainwater to drain naturally. The softly shaped frame and handle sit comfortably in the hand, while large, sturdy wheels ensure smooth movement from patio to living room.



Designed by:
Odosdesign

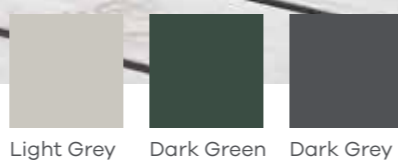

mindo 103

Minimal in form.
Deeply comfortable
by design. Shaped for
well-being and calm.



Designed by:
Thomas E. Alken



mind **103**

A place to
unwind, together.

mindocom 103



mindo 103 Daybed L197 cm · W84 cm · SH39 cm

The understated daybed is designed with comfort and well-being at its core.

Its minimal expression is confident yet quiet - strong enough to stand on its own, subtle enough to blend naturally into its surroundings. The result is a place to pause, slow down, and step away from the day. A weather-resistant cushion rests on a specially developed webbing structure, creating a deep, supportive comfort that invites long moments of rest.



The sand-coloured tone was chosen deliberately - light, neutral, and calming - so the patio remains a pleasant sight, even in winter. Made from durable polyester, the covers shield furniture from dust, dirt, and rain. A drawstring at the bottom keeps them securely in place, even in windy conditions.

Who knew covered furniture could look this good?



Available in a range of sizes, each cover is tailored to fit different mindo pieces. Subtle in expression and reliable in use, they offer practical protection with the same care and restraint found in the furniture itself.



Materials

We carefully select top-quality materials for our furniture from specialised, premium European and global suppliers committed to sustainability and to minimizing their carbon footprint. Using superior materials guarantees that our products are durable for everyday use and resilient against various weather conditions, ensuring the longevity of our products.

Fabrics



Our **fabrics**, sourced from premium European suppliers, are of consistently excellent quality. They exhibit excellent weather resistance (UV, temperature, mold) and stain resistance (antibacterial, hydrophobic). It's important to note that prolonged exposure to varying climatic impacts may decrease their effectiveness over time.

Regular removal of dirt and covering during extended periods of rain will prolong their lifetime. Stored cushions must be completely dry before covering and aired regularly.

Bamboo is a natural, very strong, and sustainable material that can be harvested every 4-6 years. Bamboo is flexible, elastic, and thus resilient to breaking, even when under pressure.

Bamboo furniture must be treated regularly with an oil suitable for outdoor furniture to maintain its high quality. Our bamboo is certified by a responsible source.



Bamboo

Teak



All our **teak** is from certified forests, meeting all strict international regulations. The teak used in our furniture is untreated as we believe that the aging process of teak with its silver-grey patina honours this fantastic material best. All teak parts in our furniture can be replaced individually if necessary, contributing to long-lasting furniture.

Ceramic



Our Techlam® **ceramic** tabletops are produced in Spain by renowned Levantina. Ceramic is an extremely strong and practically maintenance-free material and ideal for outdoor use in almost any climate. Small variations in the surface may occur as the tops are made from natural, recycled materials. This does not affect the quality of the product. If necessary, the ceramic tiles can be replaced individually contributing to the longevity of the furniture.



Rope

Rope is made of Olyna fibers, 100% solution-dyed polypropylene, in Italy and completely recyclable, soft and “wool-like” to the touch, compliant with the Oeko-Tex standard 100 class 1, anti-bacterial, and extremely resistant to climatic influences. The colours are inspired by nature, and the depth in the tones is created by weaving different coloured fibers together. In the hands of our skilled craftsmen, the material gives life to comfortable, sculptured, and unique pieces of outdoor furniture.



HPL

High-pressure laminate, also called **HPL**, is produced in Germany and is specially fabricated for outdoor use. The HPL plates are made of resin-impregnated layers of paper, pressed together under extremely high pressure and heat. The tops are weather-resistant (UV, temperature, moisture) and have an extraordinary resistance to scratches, abrasions, and impacts. Regular cleaning of the surface is the only maintenance necessary.

3D-KNIT



Our **3D-knit fabric** is a specially developed material made from recycled plastic bottles. Its advanced knit structure offers both natural flexibility and supportive comfort, shaping gently to the user’s back.

The open construction ensures excellent airflow, while the material is UV-protected and resistant to weather influences, and made to perform beautifully outdoors.

Aluminium



Aluminium is a lightweight, yet strong and durable material, ideal for outdoor furniture due to its corrosion resistance. We use state-of-the-art powder-coating techniques in our production process. Powder-coating technology is an eco-friendly and safe process to best protect and prolong longevity of outdoor furniture from weather influences as well as minor scratches. To ensure the highest quality, every frame and slat is individually treated and quality checked by our meticulous craftsmen.

Batyline Eden



Batyline Eden is a refined outdoor textile fabric with a light, open weave that allows air to flow freely. Its subtle texture gives a soft, textile feel, while the material remains UV-resistant, quick-drying, and easy to maintain. Durable and elegant, developed for life outdoors.

Materials & Colours

Frame



Aluminium Dark Grey **LH-070** Aluminium Light Grey **LH-010** Aluminium Warm Grey **LH-011** Aluminium Off-white **LH-012** Aluminium Terracotta Red **LH-013** Aluminium Dark Green **LH-014**

Table top



HPL Anthracite Grey **SE-01** Teak From certified forests Bamboo From certified forests Ceramic Opium Black **LE01** Ceramic Basic Neu **LE02** Ceramic Vulcano Concrete **LE03**



Ceramic Steel Chrome **LE05**

Other product components



Teak From certified forests Bamboo From certified forests

Rope

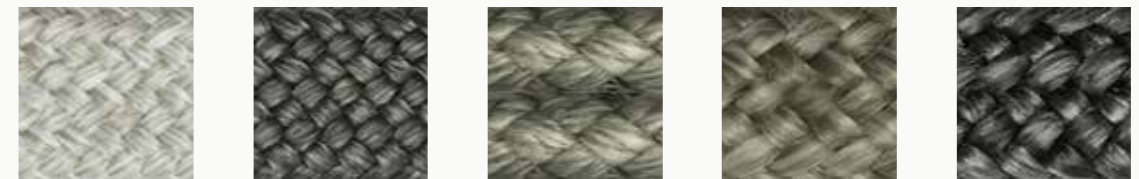

Olyna Flat 20 mm White Beige **TT00587** Olyna Flat 20 mm Dark Grey **TT00589** Olyna Round 10 mm Beige Brown **TT00593** Olyna Flat 8 mm Beige Brown **TT00591** Olyna Flat 8 mm Dark Grey **TT00592**

Fabric



Sunbrella Silver Grey **ML00049** Sunbrella Carbon **ML00558** Sunbrella Sooty **ML00481** Sunbrella Grey Chine **ML00549** Sunbrella Graumel Chalk **ML00631** Citel Amber **ML00622**
 Olyna Fabric Taupe **ML00676** Olyna Fabric White Beige **ML00617** Olyna Fabric Silver Grey **ML00618** Olyna Fabric Terracotta Red **ML00619** Batyline Beige Mix **ML00646** Batyline Brown/Grey Mix **ML00648**

3D-Knit



3D-Knit Light Grey Melange **MG66** 3D-Knit Beige **Z83**

Instagram

#MINDO_MOMENTS

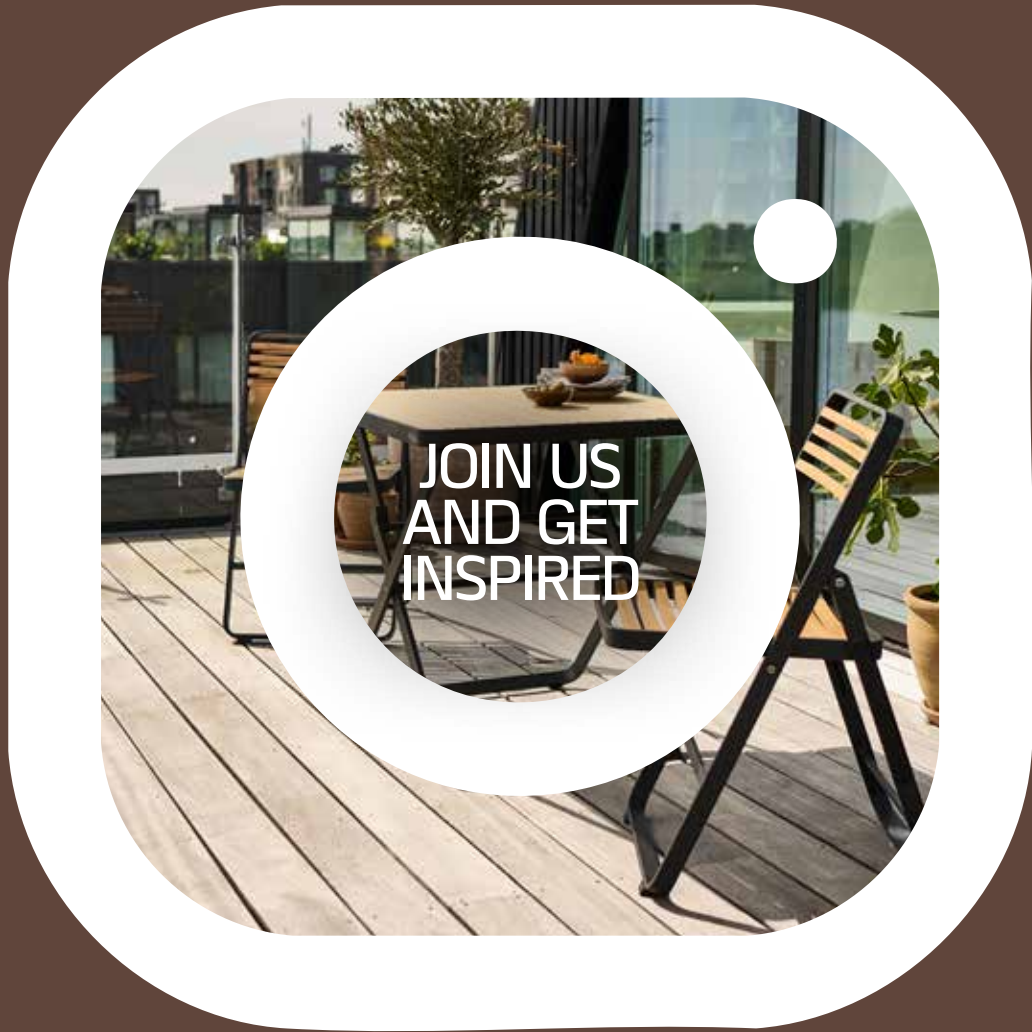

DISCOVER US ONLINE



MINDO.COM



MINDOMOMENTS



MINDO_MOMENTS



MINDOOUTDOOR
FURNITURE



MINDO GROUP
INTERNATIONAL